**KLT-USB-1467 V1****8.46MP 1467 Sony IMX415 M12 Auto Focus USB 2.0 Camera Module**

KLT-USB-1467 V1 is an 8MP Auto Focus USB 2.0 camera module based on 1/2.8" IMX415 image sensor. It delivers high-speed, 4K resolution ultra sharp image. The S-mount (M12) lens holder enables customers to choose different lens as per varies applications. This camera module is ideal solution for face recognition, identity detection, automotive, access control.

Key Features

- 4K resolution (3864 x 2228) Sony IMX415 sensor
- High speed USB 2.0 Plug and Play
- MJPG and YUV1 output format
- Low power consumption
- Compact size
- UVC compliant to Windows, Linux, OS with UVC driver
- USB OTG (On-The-Go) support

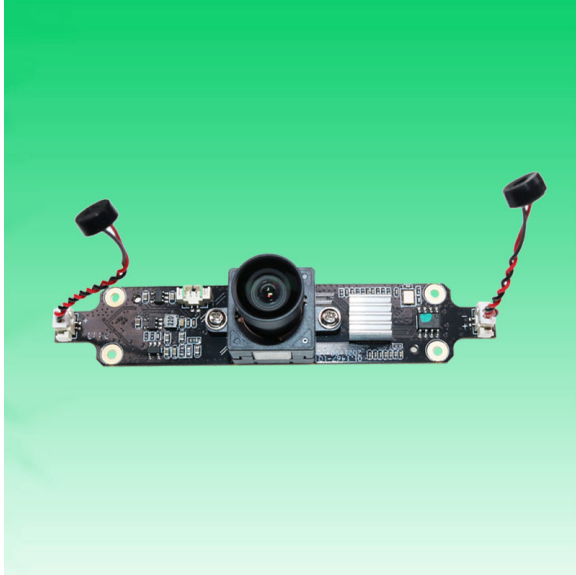

KLT-USB-1467 V1

8.46MP 1467 Sony IMX415 M12 Auto Focus USB 2.0 Camera Module

Camera Module No.	KLT-USB-1467 V1
Resolution	8.46MP
Image Sensor	IMX415
Sensor Type	1/2.8"
Pixel Size	1.45 um x 1.45 um
EFL	3.24 mm
F.NO	2.70
Pixel	3864 x 2228
View Angle	88.2°(DFOV) 80.2°(HFOV) 51.0°(VFOV)
Lens Dimensions	18.00 x 18.00 x 22.50 mm
Module Type	Auto Focus
Interface	USB 2.0
Output Format	MJPEG / YUV2
Auto Control	Saturation, Contrast, Acutance White Balance, Exposure
Audio	Optional
Input Voltage	DC 5V
Working Current	Max 500mA
PCB Size	96.00 x 18.00 mm
System Compatibility	Windows XP (SP2, SP3), Vista, 7, 8, 10, 11 Android, Mac OS, Linux or OS with UVC Driver Raspberry Pi by USB Port
Software for USB Camera	AMCAP, Webcam Viewer, V4L2 Controls Contacam, VLC Player, MotionEye OS iSpy, ZoneMider, Yawcam
Lens Type	650nm IR Cut
Operating Temperature	-30°C to +85°C
USB Cable	USB Cable

Wide Compatibility with Windows, Android, Mac OS, Linux, or Raspberry Pi

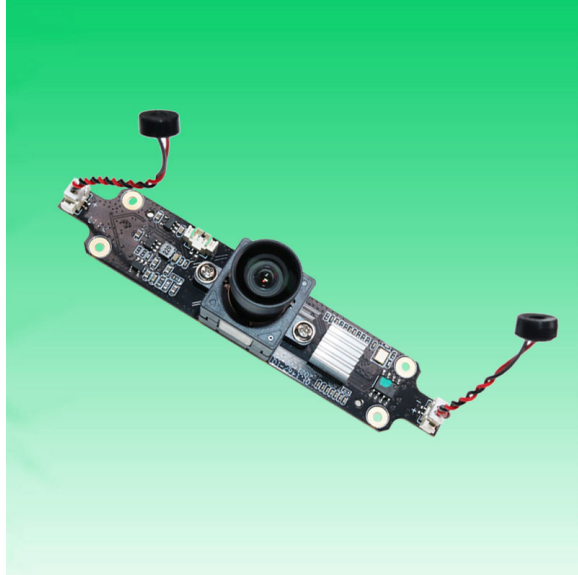

www.KaiLapTech.com sales@KaiLapTech.com Tel: (852) 6908 1256 Fax: (852) 3017 6778

**KLT-USB-1467 V1****8.46MP 1467 Sony IMX415 M12 Auto Focus USB 2.0 Camera Module**

Top View

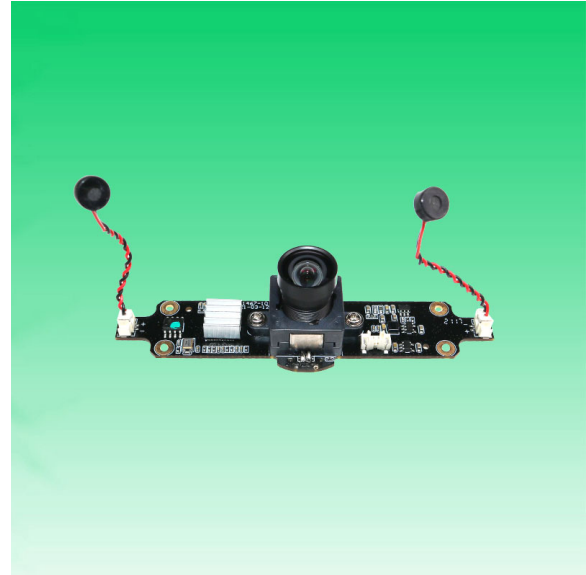

Side View



Bottom View

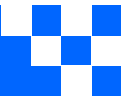

USB Cable

**KLT-USB-1467 V1****8.46MP 1467 Sony IMX415 M12 Auto Focus USB 2.0 Camera Module**

FORMAT	RESOLUTION	FRAME RATE
		USB 2.0
MJPG	1280 x 720 (720P)	20 FPS
	1920 x 1080 (1080P)	20 FPS
	2880 x 2160 (6MP)	20 FPS
	3840 x 2160 (7.5MP)	20 FPS
YUV2	1280 x 720 (720P)	10 FPS
	1920 x 1080 (1080P)	10 FPS
	2880 x 2160 (6MP)	1 FPS
	3840 x 2160 (7.5MP)	1 FPS



Version	Information	Date
V1.0	First Version	10-31-2023

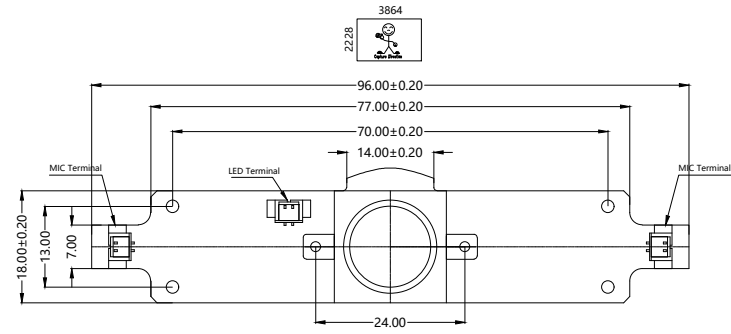

TOP VIEW

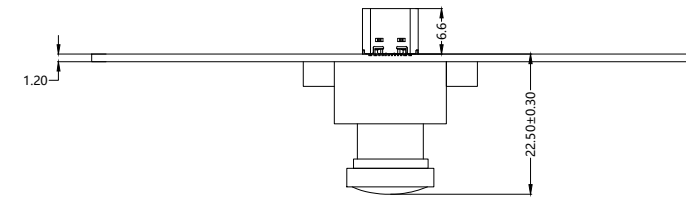

SIDE VIEW

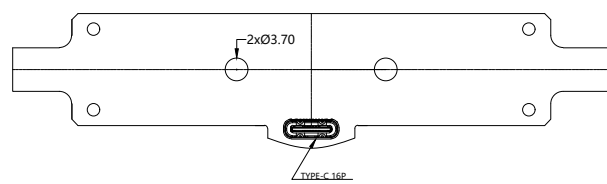

BOTTOM VIEW

Parameter:

1、 Sensor specification:

Image Sensor: IMX415

Pixel: 1.45um*1.45um

Lens Type: 1/2.8

Important Voltage Description:

USB 5V (external power supply);

2、 Lens specification:

FOV: 88.2°(D);80.2°(H);51°(V)

F/NO.: 2.7

TV distortion: <-0.12%

Focallength: 3.24

Composition: 4G2P+IR FILTER

IR Cut Coating: 650nm±10nm@50%

Kai Lap Technologies Group Ltd

Designed By	Kevin	Model Name:	KLT-USB-1467 V1		
Checked By	Jacky	Projection Type:	Unit: mm	Material: -----	
		 Third Angle	Scale: 1:1	Sheet: 1 of 1	Version: 1/0

[Product Information]

IMX415-AAQR

Ver.1.0

Diagonal 6.43 mm (Type 1/2.8) CMOS Solid-state Image Sensor with Square Pixel for Color Cameras

Description

The IMX415-AAQR is a diagonal 6.4 mm (Type 1/2.8) CMOS active pixel type solid-state image sensor with a square pixel array and 8.46 M effective pixels. This chip operates with analog 2.9 V, digital 1.1 V, and interface 1.8 V triple power supply, and has low power consumption. High sensitivity, low dark current and no smear are achieved through the adoption of R, G and B primary color mosaic filters. This chip features an electronic shutter with variable charge-integration time.

(Applications: Surveillance cameras, FA cameras, Industrial cameras)

Features

- ◆ CMOS active pixel type dots
- ◆ Built-in timing adjustment circuit, H/V driver and serial communication circuit
- ◆ Input frequency: 24 MHz / 27 MHz / 37.125 MHz / 72 MHz / 74.25 MHz
- ◆ Number of recommended recording pixels: 3840 (H) × 2160 (V) approx. 8.29 M pixels
- ◆ Readout mode
 - All-pixel scan mode
 - Horizontal / Vertical 2/2-line binning mode
 - Window cropping mode
 - Horizontal / Vertical direction - Normal / Inverted readout mode
- ◆ Readout rate
 - Maximum frame rate in
 - All-pixel scan mode: 12 bit: 60.3 frame/s, 10 bit: 90.9 frame/s
- ◆ High dynamic range (HDR) function
 - Multiple exposure HDR
 - Digital overlap HDR
- ◆ Synchronizing sensors function
- ◆ Variable-speed shutter function (resolution 1H units)
- ◆ CDS / PGA function
 - 0 dB to 30 dB : Analog Gain 30 dB (step pitch 0.3 dB)
 - 30.3 dB to 72 dB : Analog Gain 30 dB + Digital Gain 0.3 dB to 42 dB (step pitch 0.3 dB)
- ◆ Supports I/O
 - CSI-2 serial data output (2 Lane / 4 Lane), RAW10 / RAW12 output
- ◆ Recommended exit pupil distance: -30 mm to $-\infty$

STARVIS

* STARVIS is a trademark of Sony Corporation. The STARVIS is back-illuminated pixel technology used in CMOS image sensors for surveillance camera applications. It features a sensitivity of 2000 mV or more per $1 \mu\text{m}^2$ (color product, when imaging with a 706 cd/m^2 light source, F5.6 in 1 s accumulation equivalent), and realizes high picture quality in the visible-light and near infrared light regions.

Sony reserves the right to change products and specifications without prior notice.
Sony logo is a registered trademark of Sony Corporation.

Device Structure

- ◆ CMOS image sensor
- ◆ Image size Diagonal 6.4 mm (Type 1/2.8) approx. 8.40 M pixels, All pixels
- ◆ Total number of pixels 3864 (H) × 2228 (V) approx. 8.60 M pixels
- ◆ Number of effective pixels 3864 (H) × 2192 (V) approx. 8.46 M pixels
- ◆ Number of active pixels 3864 (H) × 2176 (V) approx. 8.40 M pixels
- ◆ Number of recommended recording pixels 3840 (H) × 2160 (V) approx. 8.29 M pixels
- ◆ Unit cell size 1.45 μm (H) × 1.45 μm (V)
- ◆ Optical black
Horizontal (H) direction: Front 0 pixel, rear 0 pixel
Vertical (V) direction: Front 36 pixels, rear 0 pixel
- ◆ Dummy
Horizontal (H) direction: Front 0 pixel, rear 0 pixel
Vertical (V) direction: Front 1 pixel, rear 1 pixel
- ◆ Package 114 pin LGA

Image Sensor Characteristics

(Tj = 60 °C)

Item		Value	Remarks
Sensitivity (F5.6)	Typ.	2048 Digit	1/30 s accumulation 12 bit converted value
Saturation signal	Min.	3895 Digit	12 bit converted value

Basic Drive Mode

Drive mode	Recommended number of recording pixels	Maximum frame rate [frame/s]	Output interface	ADC [bit]
All pixel	3840 (H) × 2160 (V) approx. 8.29 M pixels	90.9	CSI-2	10
Horizontal/ Vertical 2/2-line binning	1920 (H) × 1080 (V) approx. 2.07 M pixels	90.9	CSI-2	10

[Product Information]

IMX415-AAMR

Ver.1.0

Diagonal 6.43 mm (Type 1/2.8) CMOS Solid-state Image Sensor with Square Pixel for Monochrome Cameras

Description

The IMX415-AAMR is a diagonal 6.4 mm (Type 1/2.8) CMOS active pixel type solid-state image sensor with a square pixel array and 8.46 M effective pixels. This chip operates with analog 2.9 V, digital 1.1 V, and interface 1.8 V triple power supply, and has low power consumption. High sensitivity, low dark current and no smear are achieved. This chip features an electronic shutter with variable charge-integration time.

(Applications: Surveillance cameras, FA cameras, Industrial cameras)

Features

- ◆ CMOS active pixel type dots
- ◆ Built-in timing adjustment circuit, H/V driver and serial communication circuit
- ◆ Input frequency: 24 MHz / 27 MHz / 37.125 MHz / 72 MHz / 74.25 MHz
- ◆ Number of recommended recording pixels: 3840 (H) × 2160 (V) approx. 8.29 M pixels
- ◆ Readout mode
 - All-pixel scan mode
 - 2 × 2 adjacent pixel binning mode
 - Window cropping mode
 - Horizontal / Vertical direction - Normal / Inverted readout mode
- ◆ Readout rate
 - Maximum frame rate in
 - All-pixel scan mode: 12 bit: 60.3 frame/s, 10 bit: 90.9 frame/s
- ◆ High dynamic range (HDR) function
 - Multiple exposure HDR
 - Digital overlap HDR
- ◆ Synchronizing sensors function
- ◆ Variable-speed shutter function (resolution 1H units)
- ◆ CDS / PGA function
 - 0 dB to 30 dB : Analog Gain 30 dB (step pitch 0.3 dB)
 - 30.3 dB to 72 dB : Analog Gain 30 dB + Digital Gain 0.3 dB to 42 dB (step pitch 0.3 dB)
- ◆ Supports I/O
 - CSI-2 serial data output (2 Lane / 4 Lane), RAW10 / RAW12 output
- ◆ Recommended exit pupil distance: -100 mm to $-\infty$

STARVIS

* STARVIS is a trademark of Sony Corporation. The STARVIS is back-illuminated pixel technology used in CMOS image sensors for surveillance camera applications. It features a sensitivity of 2000 mV or more per $1 \mu\text{m}^2$ (color product, when imaging with a 706 cd/m² light source, F5.6 in 1 s accumulation equivalent), and realizes high picture quality in the visible-light and near infrared light regions.

Sony reserves the right to change products and specifications without prior notice.
Sony logo is a registered trademark of Sony Corporation.

Device Structure

- ◆ CMOS image sensor
- ◆ Image size Diagonal 6.4 mm (Type 1/2.8) approx. 8.40 M pixels, All pixels
- ◆ Total number of pixels 3864 (H) × 2228 (V) approx. 8.60 M pixels
- ◆ Number of effective pixels 3864 (H) × 2192 (V) approx. 8.46 M pixels
- ◆ Number of active pixels 3864 (H) × 2176 (V) approx. 8.40 M pixels
- ◆ Number of recommended recording pixels 3840 (H) × 2160 (V) approx. 8.29 M pixels
- ◆ Unit cell size 1.45 μm (H) × 1.45 μm (V)
- ◆ Optical black
Horizontal (H) direction: Front 0 pixel, rear 0 pixel
Vertical (V) direction: Front 36 pixels, rear 0 pixel
- ◆ Dummy
Horizontal (H) direction: Front 0 pixel, rear 0 pixel
Vertical (V) direction: Front 1 pixel, rear 1 pixel
- ◆ Package 114 pin LGA

Image Sensor Characteristics

(Tj = 60 °C)

Item		Value	Remarks
Sensitivity (F8)	Typ.	1570 Digit	1/30 s accumulation 12 bit converted value
Saturation signal	Min.	3895 Digit	12 bit converted value

Basic Drive Mode

Drive mode	Recommended number of recording pixels	Maximum frame rate [frame/s]	Output interface	ADC [bit]
All pixel	3840 (H) × 2160 (V) approx. 8.29 M pixels	90.9	CSI-2	10
2 × 2 adjacent pixel binning	1920 (H) × 1080 (V) approx. 2.07 M pixels	90.9	CSI-2	10

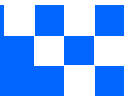

Cameras Applications



Automotive Driver Pilot



Live Streaming



Video Conference



Eye Tracker Biometric Detection

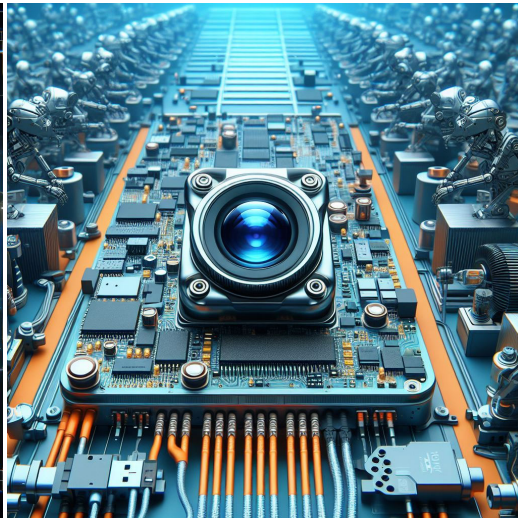

Machine Vision



Agricultural Monitor

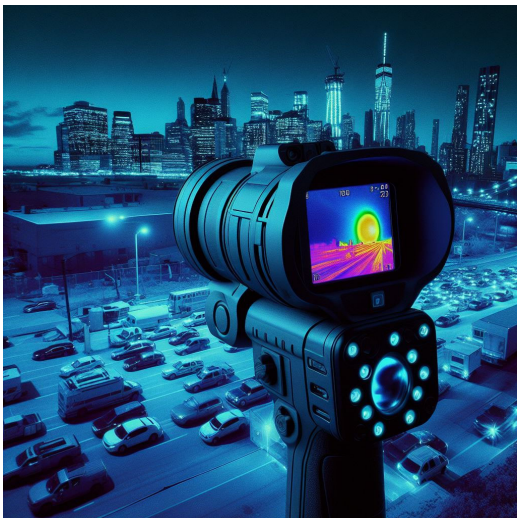

Night Vision Security



Drone and Sports Eagle Eyes



Interactive Pet Camera



your **BEST** camera module partner

Cameras Applications





Camera Module Pinout Definition Reference Chart

OmniVision	Sony	Samsung	On-Semi	Aptina	Himax	GalaxyCore	PixArt	SmartSens	Sensors
Pin Signal									
Description									
DGND	GND								
AGND									
PCLK	DCK								
XCLR	PWDN	XSHUTDOWN	STANDBY						
MCLK	XVCLK	XCLK	INCK						
RESET	RST								
NC	NULL								
SDA	SIO_D	SIOD							
SCL	SIO_C	SIOC							
VSYNC	XVS	FSYNC							
HREF	XHS								
DOVDD									
AFVDD									
AVDD									
DVDD									
STROBE	FSTROBE								
FSIN									
SID									
ILPWM									
FREX									
GPIO									
SLASEL									
AFEN									
MIPI Interface									
MDN0	DN0	MD0N	DATA_N	DMO1N					
MDP0	DP0	MD0P	DATA_P	DMO1P					
MDN1	DN1	MD1N	DATA2_N	DMO2N					
MDP1	DP1	MD1P	DATA2_P	DMO2P					
MDN2	DN2	MD2N	DATA3_N	DMO3N					
MDP2	DP2	MD2P	DATA3_P	DMO3P					
MDN3	DN3	MD3N	DATA4_N	DMO4N					
MDP3	DP3	MD3P	DATA4_P	DMO4P					
MCN	CLKN	CLK_N	DCKN						
MCP	CLKP	MCP	CLK_P	DCKN					
DVP Parallel Interface									
D0	DO0	Y0							
D1	DO1	Y1							
D2	DO2	Y2							
D3	DO3	Y3							
D4	DO4	Y4							
D5	DO5	Y5							
D6	DO6	Y6							
D7	DO7	Y7							
D8	DO8	Y8							
D9	DO9	Y9							
D10	DO10	Y10							
D11	DO11	Y11							

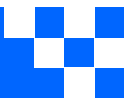

Camera Reliability Test

Reliability Inspection Item		Testing Method	Acceptance Criteria	
Category	Item			
Environmental	Storage Temperature	High 60°C 96 Hours	Temperature Chamber	No Abnormal Situation
		Low -20°C 96 Hours	Temperature Chamber	No Abnormal Situation
	Operation Temperature	High 60°C 24 Hours	Temperature Chamber	No Abnormal Situation
		Low -20°C 24 Hours	Temperature Chamber	No Abnormal Situation
	Humidity	60°C 80% 24 Hours	Temperature Chamber	No Abnormal Situation
	Thermal Shock	High 60°C 0.5 Hours Low -20°C 0.5 Hours Cycling in 24 Hours	Temperature Chamber	No Abnormal Situation
Physical	Drop Test (Free Falling)	Without Package 60cm	10 Times on Wood Floor	Electrically Functional
		With Package 60cm	10 Times on Wood Floor	Electrically Functional
	Vibration Test	50Hz X-Axis 2mm 30min	Vibration Table	Electrically Functional
		50Hz Y-Axis 2mm 30min	Vibration Table	Electrically Functional
		50Hz Z-Axis 2mm 30min	Vibration Table	Electrically Functional
	Cable Tensile Strength Test	Loading Weight 4 kg 60 Seconds Cycling in 24 Hours	Tensile Testing Machine	Electrically Functional
Electrical	ESD Test	Contact Discharge 2 KV	ESD Testing Machine	Electrically Functional
		Air Discharge 4 KV	ESD Testing Machine	Electrically Functional
	Aging Test	On/Off 30 Seconds Cycling in 24 Hours	Power Switch	Electrically Functional
	USB Connector	On/Off 250 Times	Plug and Unplug	Electrically Functional





Inspection Item		Inspection Method	Standard of Inspection		
Category	Item				
Appearance	FPC/ PCB	Color	The Naked Eye	Major Difference is Not Allowed.	
		Be Torn/Chopped	The Naked Eye	Copper Crack Exposure is Not Allowed.	
		Marking	The Naked Eye	Clear, Recognizable (Within 30cm Distance)	
	Holder	Scratches	The Naked Eye	The Inside Crack Exposure is Not Allowed	
		Gap	The Naked Eye	Meet the Height Standard	
		Screw	The Naked Eye	Make Sure Screws Are Presented (If Any)	
		Damage	The Naked Eye	The Inside Crack Exposure is Not Allowed	
	Lens	Scratch	The Naked Eye	No Effect On Resolution Standard	
		Contamination	The Naked Eye	No Effect On Resolution Standard	
		Oil Film	The Naked Eye	No Effect On Resolution Standard	
		Cover Tape	The Naked Eye	No Issue On Appearance.	
	Function	Image	No Communication	Test Board	Not Allowed
			Bright Pixel	Black Board	Not Allowed In the Image Center
Dark Pixel			White board	Not Allowed In the Image Center	
Blurry			The Naked Eye	Not Allowed	
No Image			The Naked Eye	Not Allowed	
Vertical Line			The Naked Eye	Not Allowed	
Horizontal Line			The Naked Eye	Not Allowed	
Light Leakage			The Naked Eye	Not Allowed	
Blinking Image			The Naked Eye	Not Allowed	
Bruise			Inspection Jig	Not Allowed	
Resolution			Chart	Follows Outgoing Inspection Chart Standard	
Color			The Naked Eye	No Issue	
Noise			The Naked Eye	Not Allowed	
Corner Dark			The Naked Eye	Less Than 100px By 100px	
Color Resolution			The Naked Eye	No Issue	
Dimension	Height	The Naked Eye	Follows Approval Data Sheet		
	Width	The Naked Eye	Follows Approval Data Sheet		
	Length	The Naked Eye	Follows Approval Data Sheet		
	Overall	The Naked Eye	Follows Approval Data Sheet		

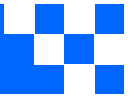

KLT Package Solutions

KLT Camera Module

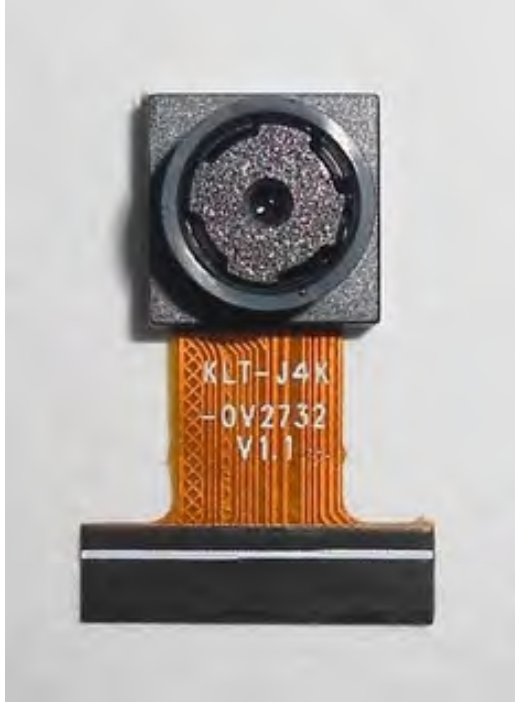

Complete with Lens Protection Film



Tray with Grid and Space



Place Cameras on the Tray

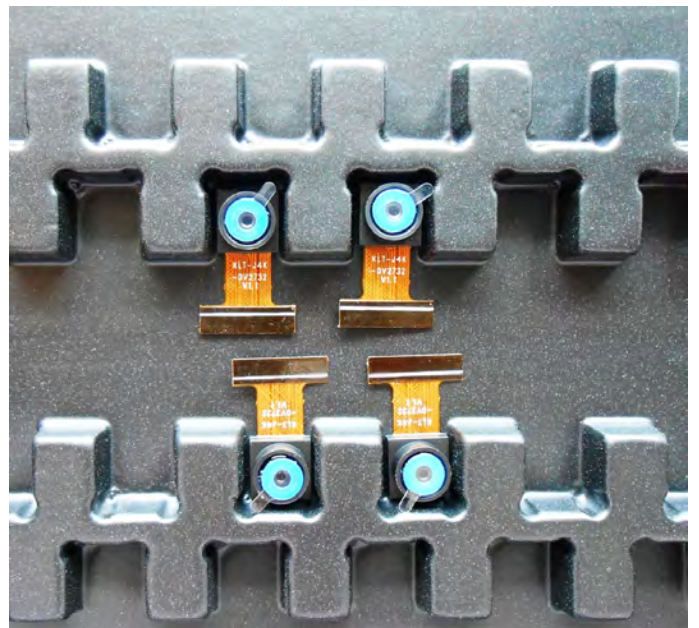

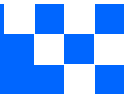

Camera Modules Package Solution

Full Tray of Cameras

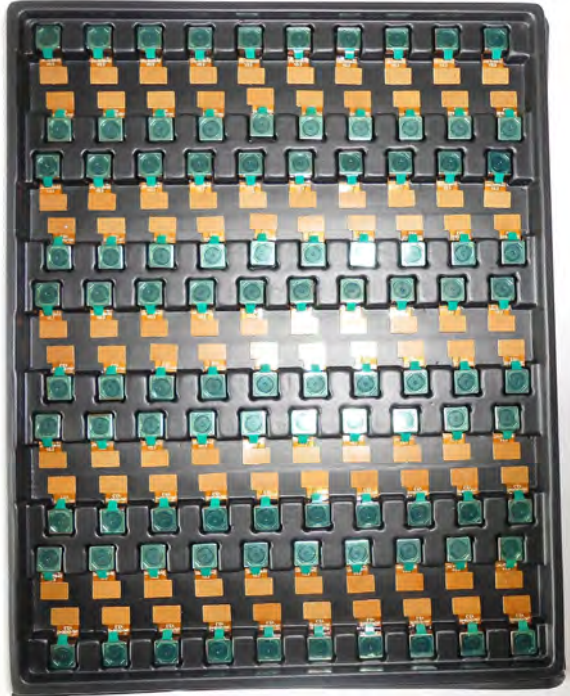

Cover Tray with Lid



Put Tray into Anti-Static Bag



Vacuum the Anti-Static Bag

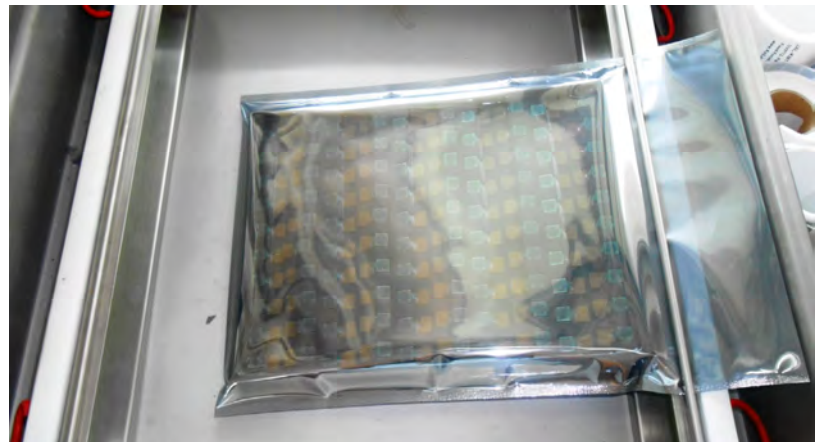



Camera Modules Package Solution

Sealed Vacuum Bag with Labels

1. Model and Description 2. Quantity 3. Shipping Date 4. Caution





Large Order Package Solution

Place Foam Sheets Between Trays



Foam Sheets are Slightly Larger than Trays



Place Foam Sheets and Trays into Box



Foam Sheets are Tightly Fitting Box



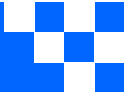

Small Order Package Solution

Place Foam Sheets and Trays into Small Box



Foam Sheets are Nicely Fitting the Small Box



Package in Small Box for Shipment



Place Small Boxes into Larger Box





your BEST camera module partner

Carbon Box Package Solution

Seal the Carbon Box

Final Package Labelled Box



Carbon Box Ready for Shipment

1. Delivery Address and Phone No. 2. Box No. and Ship Date 3. Fragile Caution





Sample Order Package Solution

Place Sample into Small Anti-Static Bag



Place Connectors into Small Ant-Static Bag



Sample Labels on the Small Bag

1. Camera Module or Connector Model 2. Shipping Date and Quantity 3. Caution



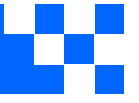

Connectors Large Order Package Solution

Connectors in a Wheel



Label Connectors in the Wheel



The Wheel is Perfectly Fitting the Box



Connectors Box Ready for Shipment





your BEST camera module partner

Company Kai Lap Technologies (KLT)

Kai Lap Technologies Group Limited. (KLT) was established in 2009, a next-generation technology driven manufacturer specialized in research, design, and produce of audio and video products. KLT is occupying 20,000 square feet automated plants with 100 employees of annual throughput 30,000,000 units cameras.

KLT provides OEM, ODM design, contract manufacturing, and builds the camera products. You may provide the requirements to us, even with a hand draft, our sales and engineering work together to meet your needs. We consider ourselves your last-term partner in developing practical and innovative solutions.

Our team covers everything from initial concept development to mass produced product. KLT specializes in customized camera design, raw material, electronic engineering, firmware/software development, product testing, and packing design. Our experienced strategic supply systems offer a robust and dependable manufacturing capacity for orders of various sizes.

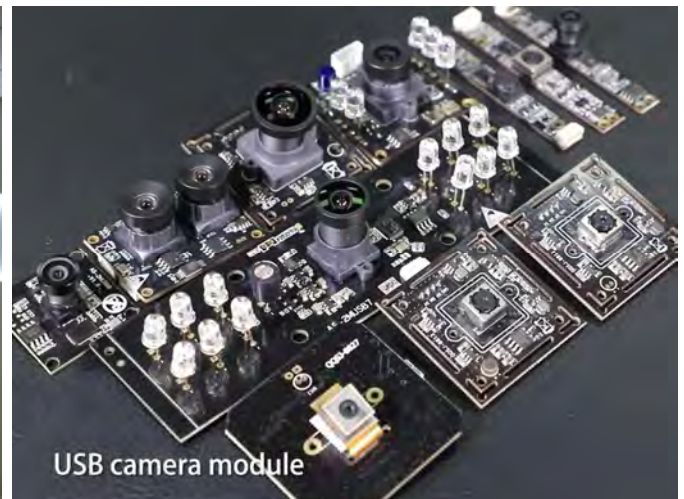

Limited Warranty

KLT provides the following limited warranty if you purchased the Product(s) directly from KLT company or from KLT's website, www.KaiLapTech.com. Product(s) purchased from other sellers or sources are not covered by this Limited Warranty. KLT guarantees that the Product(s) will be free from defects in materials and workmanship under normal use for a period of one (1) year from the date you receive the product ("Warranty Period").

For all Product(s) that contain or develop material defects in materials or workmanship during the Warranty Period, KLT will, at its sole option, either: (i) repair the Product(s); (ii) replace the Product(s) with a new or refurbished Product(s) (replacement Product(s) being of identical model or functional equivalent); or (iii) provide you a refund of the price you paid for the Product(s).

This Limited Warranty of KLT is solely limited to repair and/or replacement on the terms set forth above. KLT is not reliable or responsible for any subsequent events.





CMOS CAMERA MODULES

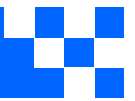

your BEST camera module partner

KLT Strength

Powerful Factory



Professional Service



Promised Delivery



www.KaiLapTech.com sales@KaiLapTech.com Tel: (852) 6908 1256 Fax: (852) 3017 6778

All rights reserved @ Kai Lap Technologies Group Ltd. Specifications subject to change without notice.